

10 YEAR MANUFACTURER'S LIMITED WARRANTY

All parts of this Kingston Brass faucet are warranted to the original retail purchaser to be free from defects in material and workmanship for a period of Ten(10) years from the date of purchase as shown on the purchaser's receipt.

This warranty is limited to defective parts only, labor charges and/or damage resulting from improper installation, repair or replacements, as well as incidental and consequential damages connected therewith are excluded.

Any damage to this faucet as a result of misuse, abuse, neglect, accident, or improper installation or any use not consistent with the instructions furnished by us, will void this warranty. Replacement parts can be obtained from your local dealer. Freight cost is not covered by manufacturer.

CAUTION!!!

1. Water lines must be completely flushed before use, to avoid debris & clogs in your water system leading to reduction of water flow and mal-functioning.
2. Warranty is void if water lines are not flushed prior to use and installation of the new faucet.
3. Use of abrasives of any strength may damage the finish of the faucet and void the product warranty.
4. Do not over tighten your faucet on the countertop during installation. The valve assembly is tested to meet the standards set by ASME A112.18.1 sec 5.8 which is listed at 100 LBF. However, over-tightened or over-torqued nuts may lead to cracks on the valve and will eventually lead to leaking and water damage.
5. Before installation of the faucet to the desired fixture, you need to secure and anchor your console, sink, tub, or vanity cabinet firmly to the wall and to the floor. To ensure your fixture or faucet mounting surface cannot be moved, before installation of the faucet, please test to see if the cabinet or vanity can be moved by hand or body weight. If the faucet mounting fixture is not secure and anchored, it will eventually crack the valve and cause leaking leading to property damage. In order to avoid this, be sure to secure your installation surface. Do not use any Power Tools for assembly and installation which can cause internal fractures to the fixture.

PROBLEMS SHOOTING

PROBLEM	CAUSE	CORRECTIVE ACTION
Leaks underneath handle	Bonnet nut has come loose	Remove the handle and tighten the bonnet nut
Leaks from the spout	Valve seat and spring are worn	Replace the valve seat and spring
Inconsistent water flow pattern	Aerator is dirty or aged	Release aerator and check on rubber gasket if aged or replace with a new aerator
Faucet is dirty	Caused by stubborn water spot	Clean with mild soap and warm water as often as possible
Handles work backward	Handle installed backward	Rotate the right stem stop assembly 180 degrees

CODE APPROVAL: LA#M-000018

KINGSTON

KITCHEN & BATH

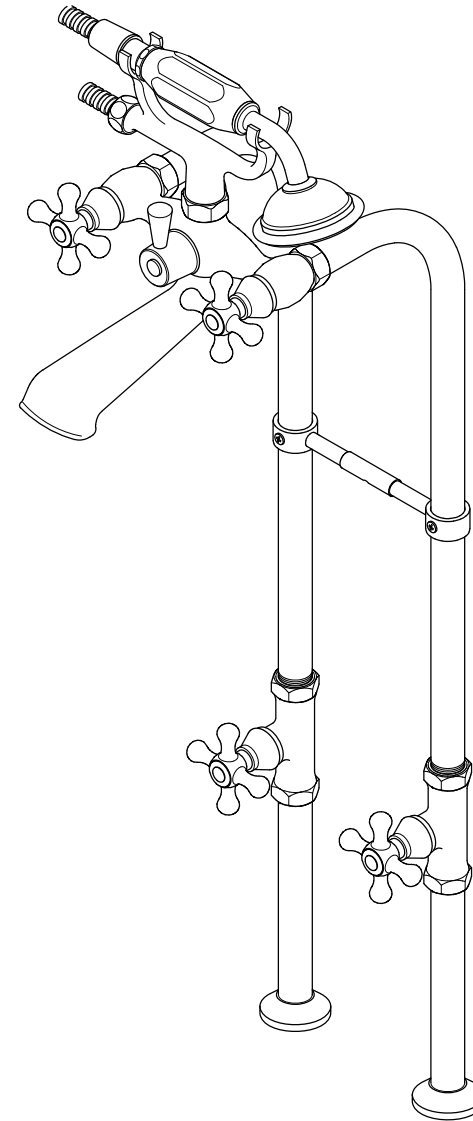

www.kingstonbrass.com

TOLL-FREE CUSTOMER SERVICE: 1-877-2-KBRASS

TECHNICAL SUPPORT E-mail: service@kingstonbrass.com

12775 Reservoir Street, Chino, CA 91710



KINGSTON

KITCHEN & BATH

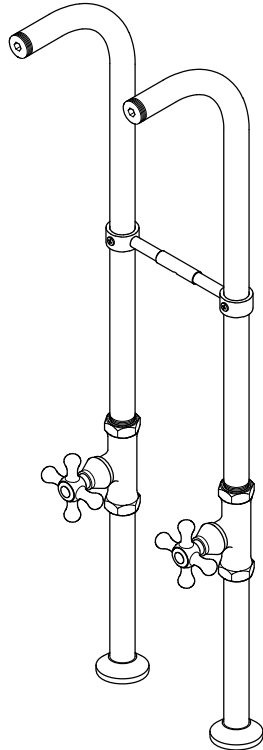
Free standing supply lines Installation



Parts:

Lock Nut	Washer & Coupling Nut	Washer
		
4 Pcs	2 Pcs	2 Pcs

www.kingstonbrass.com
 TOLL-FREE CUSTOMER SERVICE: 1-877-2-KBRASS
 TECHNICAL SUPPORT E-mail: service@kingstonbrass.com
 12775 Reservoir Street, Chino, CA 91710

This item is designed to be installed in wood floors. If you have a concrete floor it may be necessary to build a platform to accommodate the inlet connections refer to image on right.

Before starting the installation of your supply lines you should:

- Verify the center to center of your faucet and rough in your supply lines accordingly, flush lines to clear any debris left in the line.
- Allow a 6" minimum clearance below the floor to allow sufficient space for attachment of the supply lines to the intended stub out.
- Drill 1" holes at the rough in location.

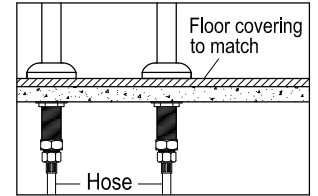

Installation Steps:

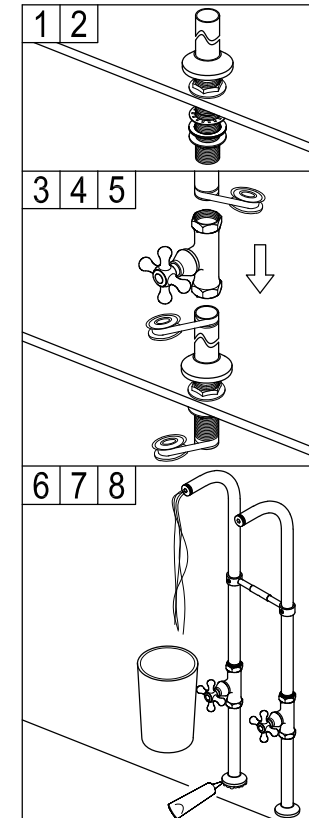

1. Insert horizontal bracket into the bottom of the 2 top risers, slide up to the desired level and tighten screws, insert flange on bottom risers.
2. Apply Teflon tape to both ends of the top riser as well as to the top portion of the lower riser.
3. Thread shut-off valve to bottom of top riser and to top portion of lower riser, make sure that the handles on the shut-off valve point in the same direction.
4. Thread locknut to the top of the bottom threads of the lower riser and insert through the pre-drilled holes on the floor.
5. Insert rubber washer and metal washer on the bottom riser, thread locknut and secure both supply lines from below the floor.
6. If your inlet supplies stub-outs are 3/4" apply Teflon tape and thread your intended water supplies, if your inlet supply stub-outs are 1/2" apply Teflon tape to the bottom of lower riser and thread 1/2" adapter (included) apply Teflon tape to 1/2" threads on adapter and thread on your supply stub out.
7. From above the floor apply a bead of silicon based caulking to the bottom of the flange and press to the floor to form a water proof barrier.
8. While holding a bucket at the outlet of the supply lines, open each valve and let water run for 30 seconds, check for leaks.

Warning!!!

Reshaping, bending or altering supply line or use of nuts or washers not supplied with this kit will void your warranty.
 Please do not pull or lean on the faucet once it has been installed, this may bend or pull the supply line which may cause a leak resulting in possible water damage.

Installer:

Please pass this installation manual to homeowner after installation. ©2022-01-T Kingston Brass

KINGSTON

KITCHEN & BATH

INSTALLATION INSTRUCTIONS Tub Filler with Supply Line & Stop Valve

BEFORE BEGINNING INSTALLATION

1. Flush plumbing lines to clear any debris.
2. Shut off both supply lines after flushing.

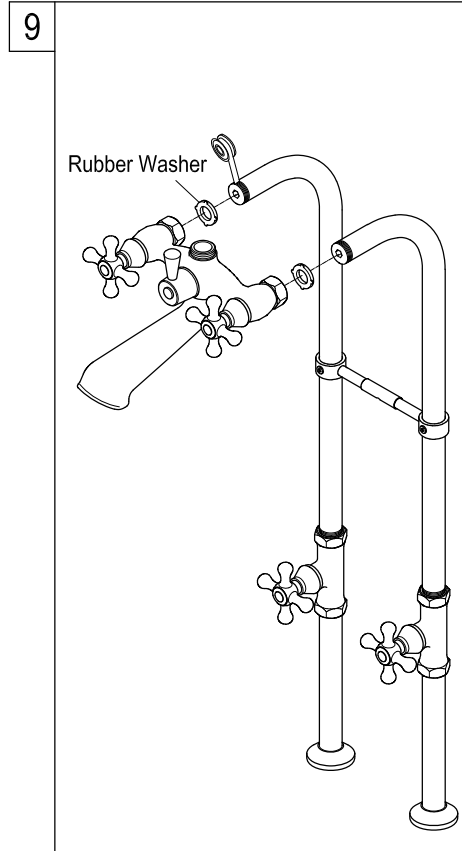

9. After applying Teflon to the top threads of the supply lines insert rubber washer into the faucets outlet and thread onto the supply lines.

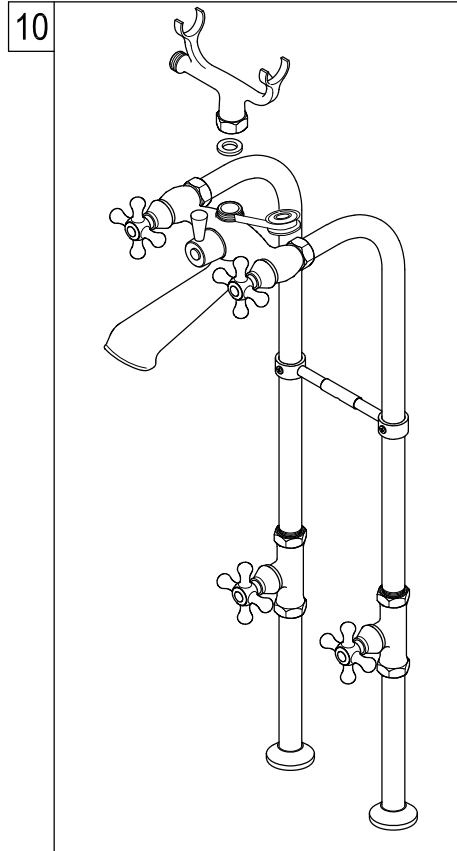

10. Apply Teflon to the top outlet on the faucet body and attach cradle.

Need Tools:

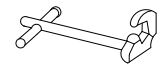

Basin Wrench



Adjustable Wrench



Teflon Tape

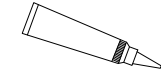

Silicone Sealant



Screwdriver

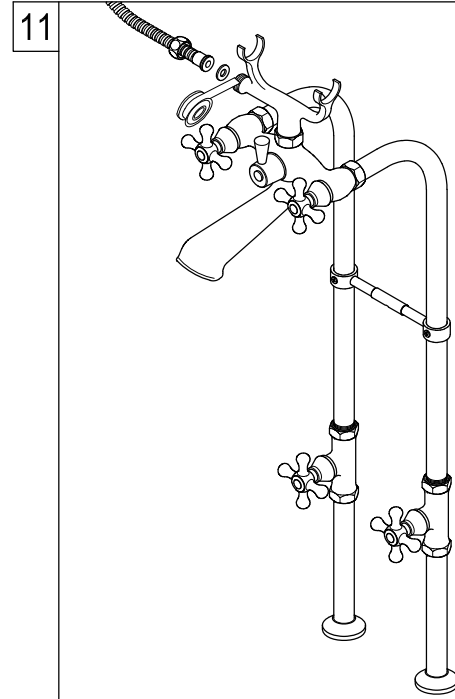

11. After applying Teflon to the hose outlet on the cradle, attach the hose.

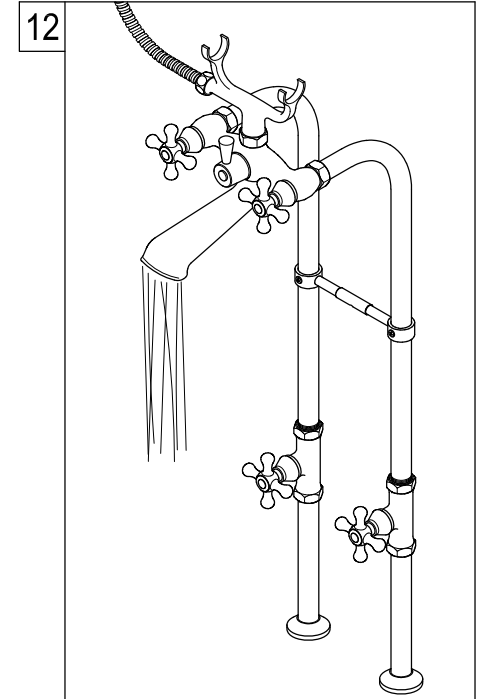

12. Open both supply lines and let the water run from the hose as well as the spout for at least 1 minute, check for leaks.

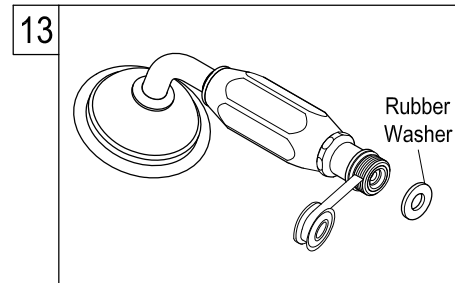

13. Apply Teflon tape on handshower inlet threads and thread on to hose, making sure the rubber washer has been inserted.

Warning!!!

- Do not put any weight, step, or hang on any part of this faucet, this may damage the faucet and cause water damage.
- This faucet was tested and meets ASME/ANSI standards of operation and torque tension; do not use pneumatic or electrical tools for its installation, as this may inadvertently over tighten the connection or attachment hardware of this faucet.
- It is recommended that the tub be situated in an area where the supply lines are not exposed to foot traffic, bumping into the supply lines may damage them and potentially cause a leak.