



OLYMPIA FAUCETS, INC.
 3325 S. Garfield Ave.
 Commerce, CA 90040
 (888) 772-7701
 www.olympiafaucets.com

INSTALLATION

Tools:



Adjustable Wrench



Plumbers Putty



Sealant Tape



Rags



Model Number: L-603X(-WD), L-609X(-WD)

Warnings and Notes:

Check with local plumbing code requirements before installation. This product should be installed by a local listed plumber. **Do not use plumbers putty on threads.**

Installation Steps:

Single Handle Lavatory Faucet

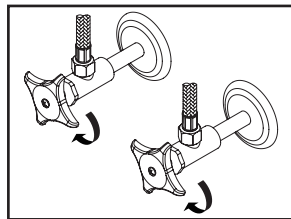

(1) Shut off the water supply. Remove old faucet. Clean mounting surface in preparation for new faucet.

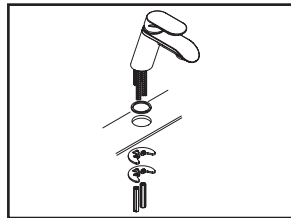

(2) **For 1-Hole Installation:** Install mounting bolts to the bottom of the faucet. Slide the gasket over the inlet supply hoses and mounting bolts. Place faucet in position on the sink. Place mounting kit over the mounting bolts under the sink. Place the rubber gasket first then the metal bracket after. Secure the mounting bolts with the mounting nuts.

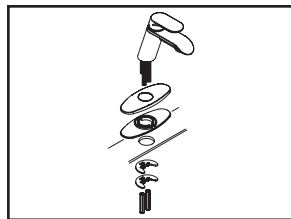

(3) **For 3-Hole Installation:** Install mounting bolts to the bottom of the faucet. Slide the gasket over the inlet supply hoses and mounting bolts. Place faucet in position on the sink. Place mounting kit over the mounting bolts under the sink. Place the rubber gasket first then the metal bracket after. Secure the mounting bolts with the mounting nuts.

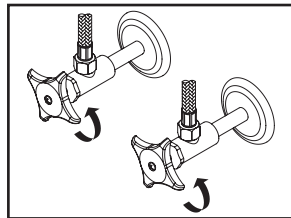

(4) Connect hot and cold inlet supply hoses to supply stops. For 1/2" connection; use 3/8" male to 1/2" female adapter for installation. Adapters are optional and not provided with faucet. Turn on both side supply stops.

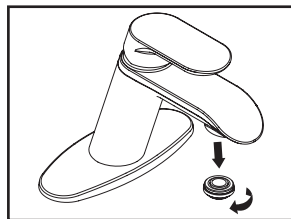

(5) Important: After installation is complete, remove the aerator. Turn on the water and allow both hot and cold water to run for at least one minute each. While water is running, check for leaks. Turn off the water and replace the aerator when finished.

Pop-Up Drain Installation:

"DO NOT USE THREAD SEALANTS, TEFLON TAPE ONLY"
"NO USE SELLADORES DE ROSCA, UTILIZAR SOLO CINTA DE TEFLON"

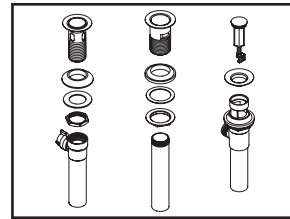

(1) a. For brass pop-up: Remove flange from drain body.

b. For 50/50 type pop-up: Remove rubber gasket, flat washer, and lock nut from metal drain body.

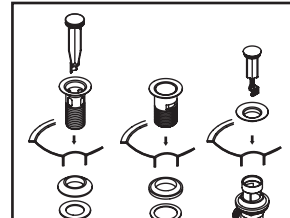

(2) a. For brass pop-up: Place a ring of plumbers putty on the bottom of the flange and apply Teflon tape on threaded tailpiece. Thread tailpiece to drain body. Insert flange through drain hole and attach drain body to flange from underneath the sink.

b. For 50/50 type pop-up: Place a ring of plumbers putty on the bottom of the flange. Insert drain body through drain hole. Thread rubber gasket, flat washer, and lock nut onto drain body. Apply Teflon tape only on the threaded area and attach tailpiece to drain body. **Please Note: Use Teflon tape only on all thread connection areas. Using pipe thread sealant might weaken material structure and cause leaks.**

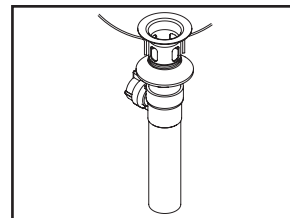

(3) Ensure the pivot rod hole on the pop-up body faces toward the back of the sink. Tighten the lock nut securely with a wrench.

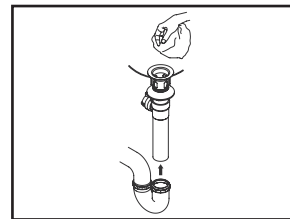

(4) Connect pop-up tail piece to the trap (check manufacturer's instruction for installation) and remove the excess plumbers putty.

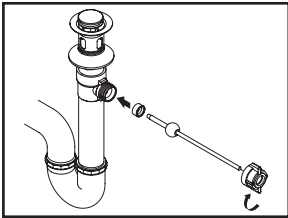

(5) Remove pivot rod nut from pop-up body and ensure the washer is in place. Insert pivot rod and tighten rod nut back to pop-up body.

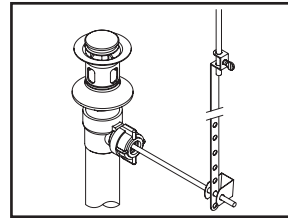

(7) Connect lift rod strap to pivot rod by using clip. Tighten thumbscrew to connect lift rod strap to pop-up lift rod.

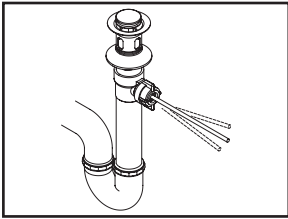

(6) Push pivot rod down and insert drain plug carefully. Test to ensure drain plug works properly.

Exploded Drawing (L-603X(-WD)):

* Note: Please specify finish/color when ordering.

	ITEM #	DESCRIPTION
A	OP-130004*	Lever Handle
B	OP-430038*	Housing
C	OP-430039	Retainer Nut
D	X-3300007	Ceramic Disc Cartridge
E	OP-430040	1.2 GPM Aerator
F	OP-430023*	Hole Cover (For L-6031(-WD), L-6033)
G	OP-430041	Screw
H	OP-430026*	Deck Plate (For "WD" Suffix)
I	OP-430042	Gasket
J	OP-530005	Mounting Kit
K	OP-630005*	50/50 Pop-Up Drain Assembly (For L-6030(-WD))
L	OP-630006*	Brass Pop-Up Drain Assembly (For L-6032(-WD))
M	OP-630007*	Push Pop-Up Drain Assembly (For L-6033)
1	OP-420047	3/32" Allen Screw
2	X-4900044*	Hole Cover

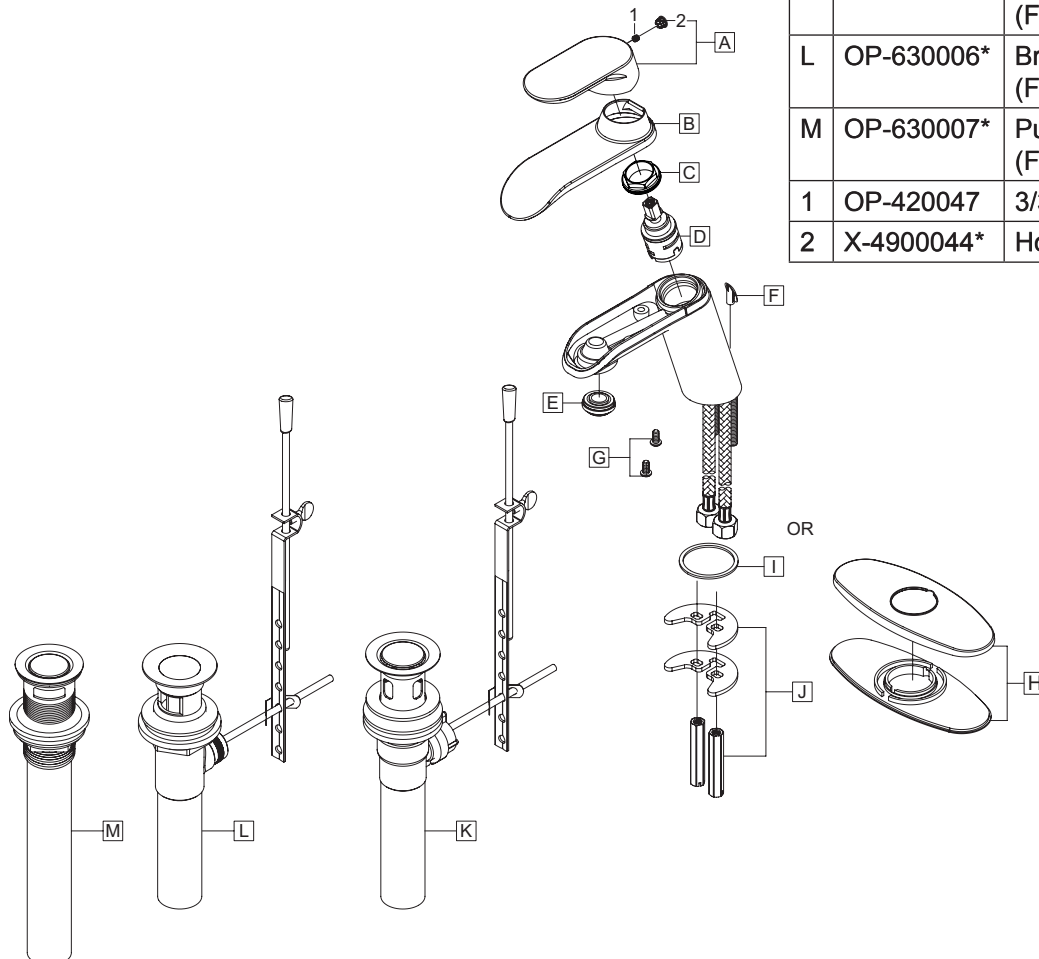

Exploded Drawing (L-609X(-WD)):

* Note: Please specify finish/color when ordering.

	ITEM #	DESCRIPTION
A	OP-130005*	Lever Handle
B	X-4300088*	Cap
C	X-4300089	Retainer Nut
D	OP-390003	Ceramic Disc Cartridge
E	OP-430045	1.2 GPM Restrictor
F	OP-490069	Aerator
G	OP-430044*	Spout Escutcheon & Gasket
H	OP-430026*	Deck Plate (For L-609X-WD)
I	OP-530005	Mounting Kit
J	OP-630013*	50/50 Pop-Up Drain Assembly (For L-6090(-WD))
K	X-6300029*	Brass Pop-Up Drain Assembly (For L-6092(-WD))
L	OP-630007*	Push Pop-Up Drain Assembly (For L-6093)
1	OP-420047	3/32" Allen Screw
2	X-4900044*	Hole Cover

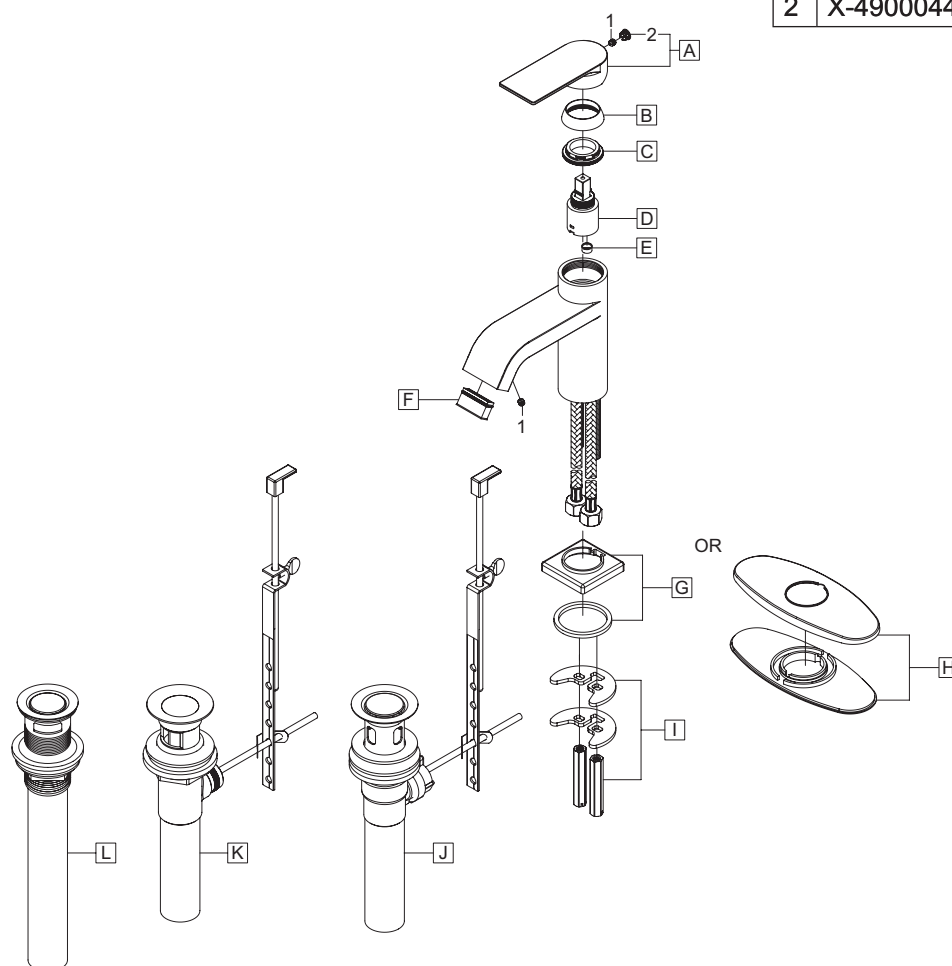

For more care information or trouble shooting inquiries about your Olympia product, Please call:
OLYMPIA FAUCETS, INC. (888) 772-7701
 Monday-Friday 8 AM to 8 PM EST (5 AM to 5 PM PST)
www.olympiafaucets.com