



OLYMPIA FAUCETS, INC.
 3325 S. Garfield Ave.
 Commerce, CA 90040
 (888) 772-7701
 www.olympiafaucets.com

INSTALLATION

Tools:



Adjustable Wrench



Plumbers Putty



Teflon Tape



Rags

Model Number: L-7220, L-7221, L-7222,
 L-7251, L-7251G, L-7290, L-7291, L-7292



Warnings and Notes:

Check with local plumbing code requirements before installation.
 This product should be installed by a local listed plumber.
Do not use plumbers putty on threads.

Installation Steps:

Two Handle Lavatory Faucet

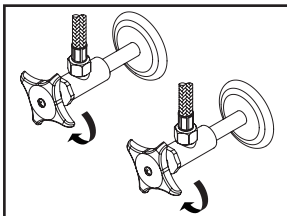

(1) Shut off the water supply. Remove old faucet. Clean mounting surface in preparation for new faucet.

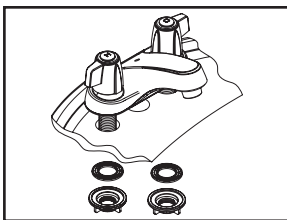

(2) Place the faucet in position on the sink. Install washer on shanks and tighten with locknut.

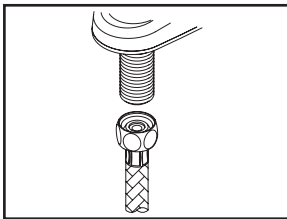

(3) When using stainless steel braided faucet supply hose; this faucet requires one end of the supply hose to have a 1/2" female IPS connection. The other end of this supply hose must match the thread on the water supply valve under your sink. Once you've identified the required size, carefully follow the manufacturer's installation instructions for each hose.

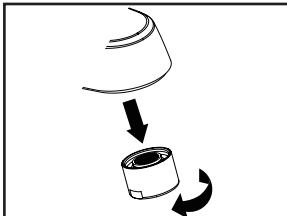

(4) Important: After installation is complete, remove the aerator. Turn on the water and allow both hot and cold water to run for at least one minute each. While water is running, check for leaks. Turn off the water and replace the aerator when finished.

Pop-Up Drain Installation:

"DO NOT USE THREAD SEALANTS, TEFLON TAPE ONLY"
"NO USE SELLADORES DE ROSCA, UTILIZAR SOLO CINTA DE TEFLON"

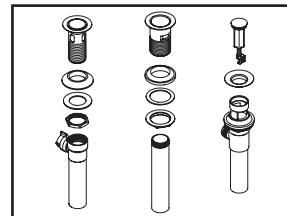

(1) a. For brass pop-up: Remove flange from drain body.

b. For 50/50 type pop-up: Remove rubber gasket, flat washer, and lock nut from metal drain body.

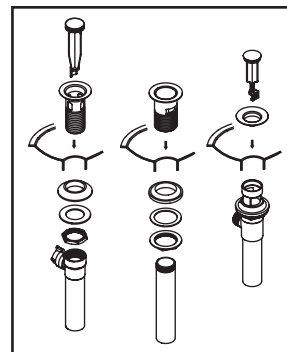

(2) a. For brass pop-up: Place a ring of plumbers putty on the bottom of the flange and apply Teflon tape on threaded tailpiece. Thread tailpiece to drain body. Insert flange through drain hole and attach drain body to flange from underneath the sink.

b. For 50/50 type pop-up: Place a ring of plumbers putty on the bottom of the flange. Insert drain body through drain hole. Thread rubber gasket, flat washer, and lock nut onto drain body. Apply Teflon tape only on the threaded area and attach tailpiece to drain body. **Please Note: Use Teflon tape only on all thread connection areas. Using pipe thread sealant might weaken material structure and cause leaks.**

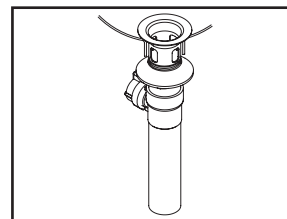

(3) Ensure the pivot rod hole on the pop-up body faces toward the back of the sink. Tighten the lock nut securely with a wrench.

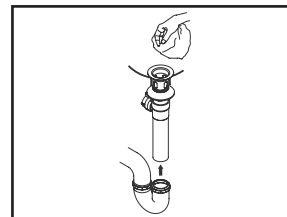

(4) Connect pop-up tail piece to the trap (check manufacturer's instruction for installation) and remove the excess plumbers putty.

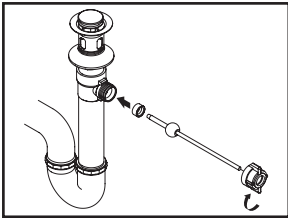

(5) Remove pivot rod nut from pop-up body and ensure the washer is in place. Insert pivot rod and tighten rod nut back to pop-up body.

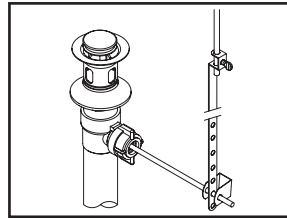

(7) Connect lift rod strap to pivot rod by using clip. Tighten thumbscrew to connect lift rod strap to pop-up lift rod.

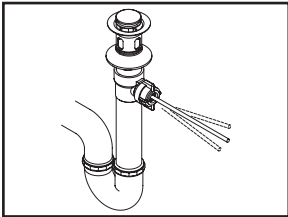

(6) Push pivot rod down and insert drain plug carefully. Test to ensure drain plug works properly.

Exploded Drawing:

	ITEM #	DESCRIPTION
H	OP-630004	50/50 Pop-Up Drain Assembly (For L-72X0)
I	OP-630002	Brass Pop-Up Drain Assembly (For L-72X2)
J	OP-630001	Brass Grid Strainer Drain Assembly (For L-7251G)
K	OP-430005	Hole Cover
1	OP-490012C, H	Acrylic Handle Button Cold, Hot
2	OP-490025	Screw
3	OP-490013C, H	Mini Blade Handle Button Cold, Hot
4	OP-490015	Handle Screw
5	OP-490016C, H	Wrist Blade Handle Button Cold, Hot

	ITEM #	DESCRIPTION
A1	OP-190003C, H	Acrylic Handle Cold, Hot (For L-722X)
A2	OP-190004C, H	Mini Blade Handle Cold, Hot (For L-729X)
A3	OP-190005C, H	Wrist Blade Handle Cold, Hot (For L-725X)
B	OP-490040	Bonnet Nut
C	OP-390004	Stem Unit-Brass Post
D	OP-490041	Springs and Seats
E	OP-490064	1.2 GPM Aerator
F	OP-590003	Mounting Hardware
G	OP-590001	Supply Nut

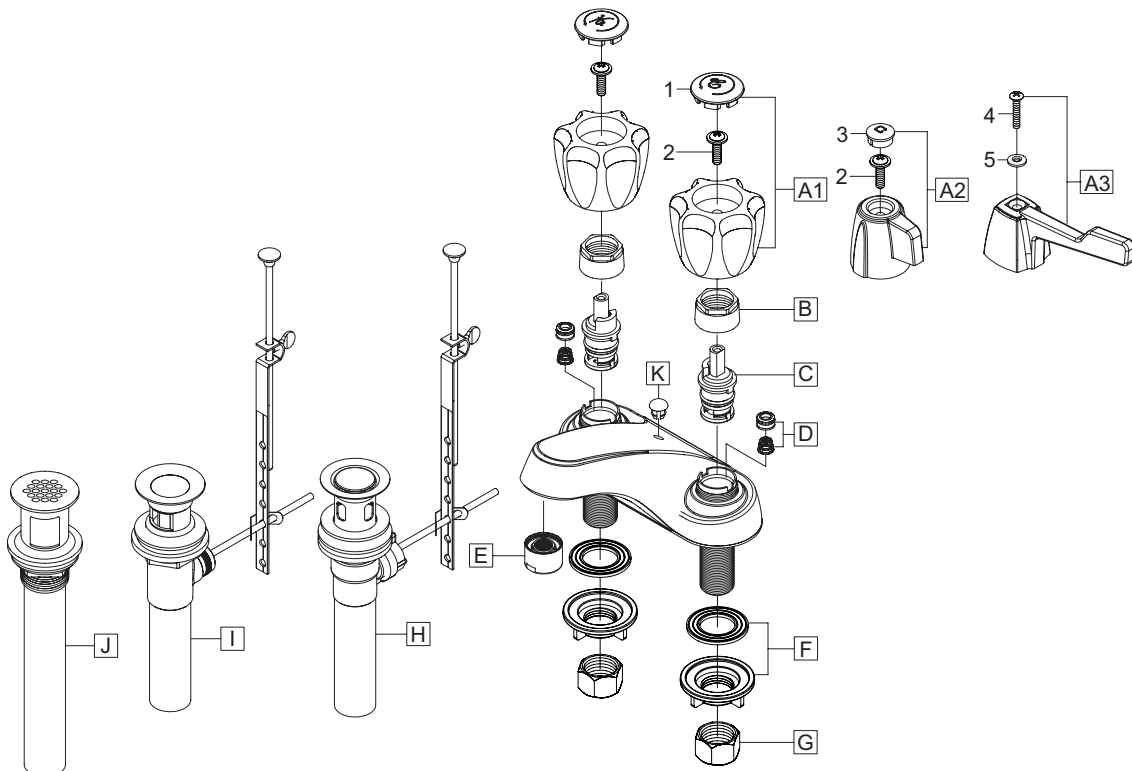

OLYMPIA

For more care information or trouble shooting inquiries about your Olympia product, Please call:
OLYMPIA FAUCETS, INC. (888) 772-7701
 Monday-Friday 8 AM to 8 PM EST (5 AM to 5 PM PST)
www.olympiafaucets.com