



PIONEER INDUSTRIES, INC.
 3325 S. Garfield Ave.
 Commerce, CA 90040
 (800) 338-9468
 www.pioneerind.com

INSTALLATION

Tools:



Adjustable Wrench



Plumbers Putty



Teflon Tape



Rags

Model Number: 2MT270, 2MT275

Warnings and Notes:

Check with local plumbing code requirements before installation.
 This product should be installed by a local listed plumber.
Do not use plumbers putty on threads.



Installation Steps:

Single Handle Pull-Down Pre-Rinse Kitchen Faucet

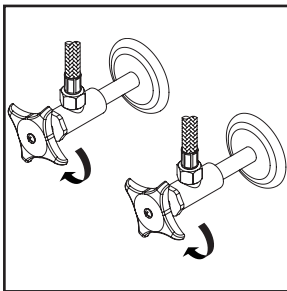

(1) Shut off the water supply. Remove old faucet. Clean mounting surface in preparation for new faucet.

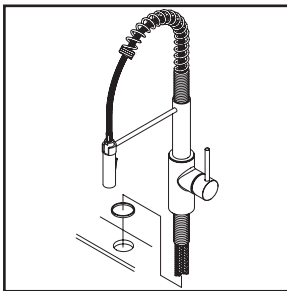

(2) Ensure there is a gasket under the faucet. Place the faucet in position on the sink.

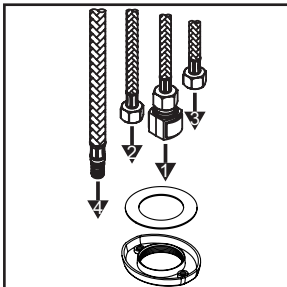

(3) With flat side of the locknut facing down and the steel washer inside the locknut please follow the order as the drawing shows to insert flex hoses through the center hole of the locknut from underneath the sink.

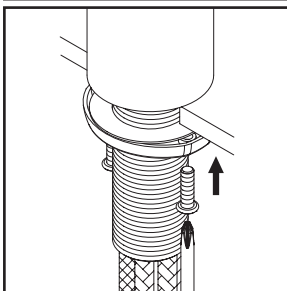

(4) Thread locknut onto the faucet shank from underneath the sink. Position faucet to desired location from the top and hand-tighten locknut till it won't go further. Thread both screws on locknut and tighten screws on locknut with the help of a Phillips head screwdriver to secure faucet. (Note: Do not overtighten.)

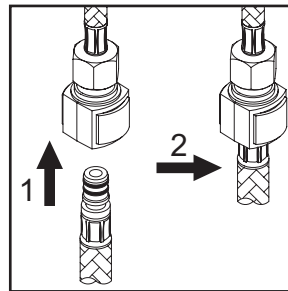

(5) Insert spray head hose into end of quick connect adapter on the outlet hose, push until a "click" is heard. Pull down to test engagement.

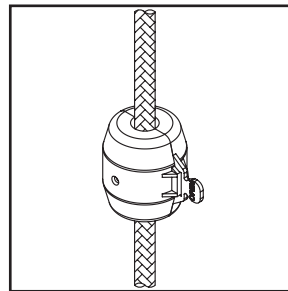

(6) Install weight on spray head hose. Adjust weight's position so the spray head can be retracted properly.

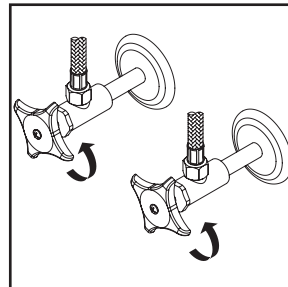

(7) Connect hot and cold inlet supply hoses to supply stops. For supply stop with 1/2" outlet connection, use 3/8" male to 1/2" female adapter for installation. Adapters are optional and are not provided with the faucet. Turn on both side supply stops to check any leaks.

Exploded Drawing :

* Note: Please specify finish/color when ordering.

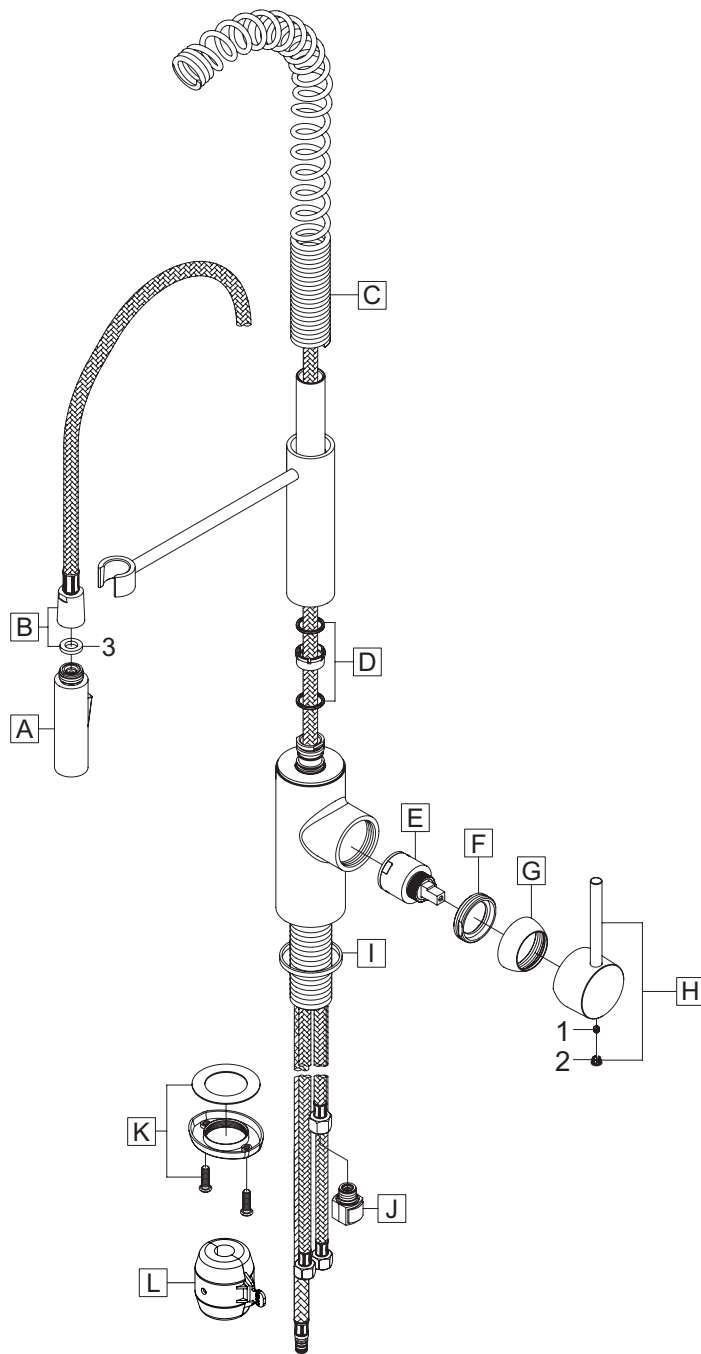

	ITEM #	DESCRIPTION
A	X-4200194*	1.5 GPM Spray Head
B	X-4200198*	Spray Hose
C	X-4200188*	Spring
D	X-4200191	Spout Repair Kit
E	X-3900008	Ceramic Disc Cartridge
F	X-4200192	Retainer Nut
G	X-4400032*	Cap
H	X-1200024*	Lever Handle
I	X-4200187	Gasket
J	X-4200199	Quick Connect
K	OP-520015	Locknut with Screws
L	OP-420070	Weight
1	X-4400024	Allen Screw
2	X-4900044*	Hole Cover
3	OP-420075	Washer



For more care information or trouble shooting inquiries about your Pioneer product, please call:
Pioneer Industries, Inc. (800) 338-9468
 Monday-Friday 8 AM to 8 PM EST (5 AM to 5 PM PST)
www.pioneerind.com