

FULTON PREP FAUCET / 3PC. SUITE

3925-3

- MAX COUNTER THICKNESS 2-3/8"
- MINIMUM INSTALL HOLE SIZE 1-1/2"

- A. Side Spray Connection with 1/4" NPT Pipe Fitting**
- B. Supply Hoses - 20" Long with 3/8" Compression Fittings**

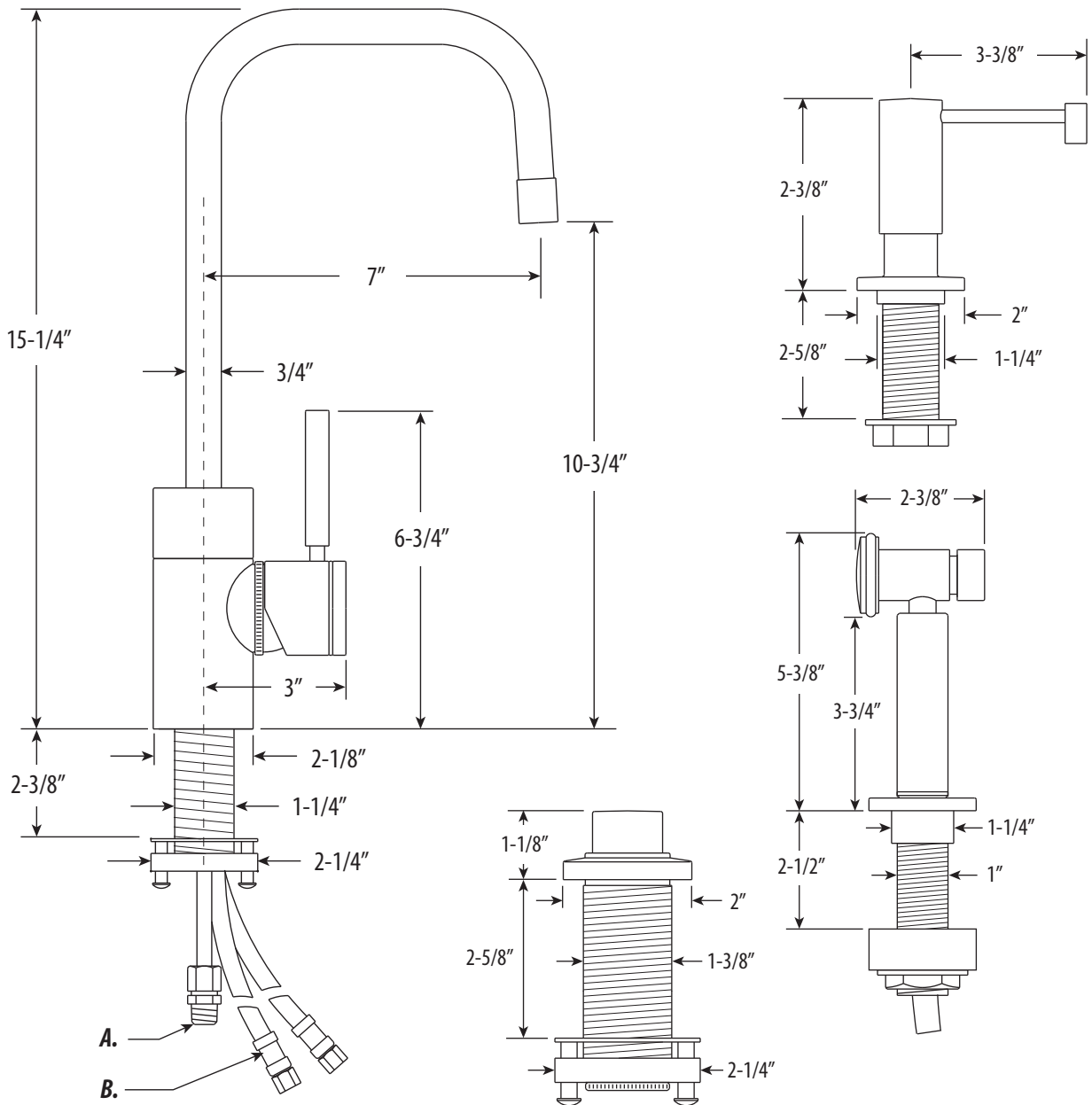

DIMENSIONS MAY VARY AND ARE SUBJECT TO CHANGE. NO RESPONSIBILITY IS ASSUMED FOR USE OF SUPERCEDED OR VOIDED DATA

